

SANYO	No.4757	2SC4924
	NPN Triple Diffused Planar Silicon Transistor Very High-Definition CRT Display Horizontal Deflection Output Applications	

Features

- High speed (t_f typ. = 100ns).
- High reliability (Adoption of HVP process).
- High breakdown voltage ($V_{CBO} = 1500V$).
- Adoption of MBIT process.

Absolute Maximum Ratings at $T_a = 25^\circ C$

			unit
Collector-to-Base Voltage	V_{CBO}	1500	V
Collector-to-Emitter Voltage	V_{CEO}	800	V
Emitter-to-Base Voltage	V_{EBO}	6	V
Collector Current	I_C	10	A
Collector Current (Pulse)	I_{CP}	25	A
Collector Dissipation	P_C	3.0	W
		70	W
Junction Temperature	T_j	150	$^\circ C$
Storage Temperature	T_{stg}	-55 to +150	$^\circ C$

$T_c = 25^\circ C$

Electrical Characteristics at $T_a = 25^\circ C$

			min	typ	max	unit
Collector Cutoff Current	I_{CBO}	$V_{CB} = 800V, I_E = 0$			10	μA
	I_{CES}	$V_{CE} = 1500V, R_{BE} = 0$			1.0	mA
Collector Sustain Voltage	$V_{CEO(sus)}$	$I_C = 100mA, I_B = 0$	800			V
Emitter Cutoff Current	I_{EBO}	$V_{EB} = 4V, I_C = 0$			1.0	mA
C-E Saturation Voltage	$V_{CE(sat)}$	$I_C = 8A, I_B = 2A$			5	V
B-E Saturation Voltage	$V_{BE(sat)}$	$I_C = 8A, I_B = 2A$			1.5	V
DC Current Gain	$h_{FE(1)}$	$V_{CE} = 5V, I_C = 1A$	8			
	$h_{FE(2)}$	$V_{CE} = 5V, I_C = 8A$	4		8	
Storage Time	t_{stg}	$I_C = 6A, I_{B1} = 1.2A, I_{B2} = -2.4A$			3.0	μs
Fall Time	t_f	$I_C = 6A, I_{B1} = 1.2A, I_{B2} = -2.4A$		0.1	0.2	μs

Switching Time Test Circuit

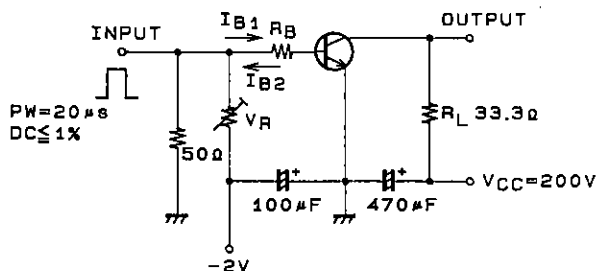

Package Dimensions 2039C (unit: mm)

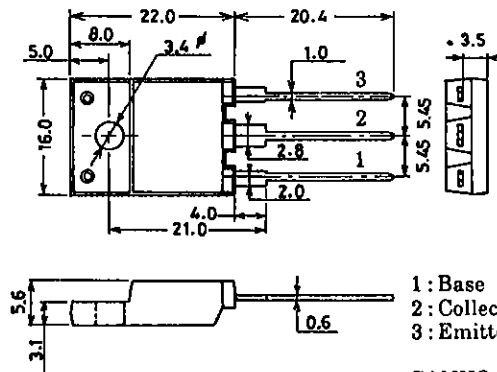

SANYO: TO-3PML

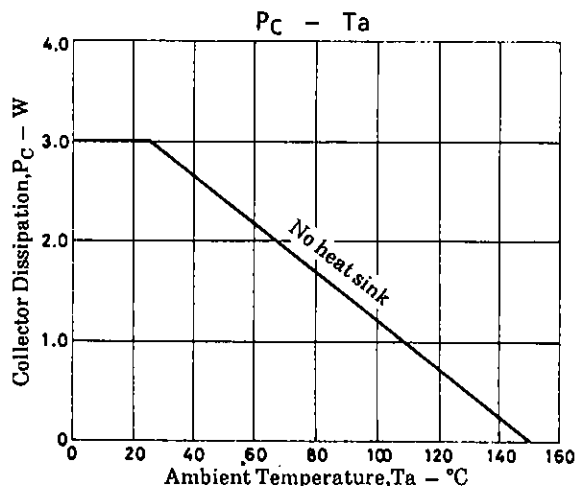
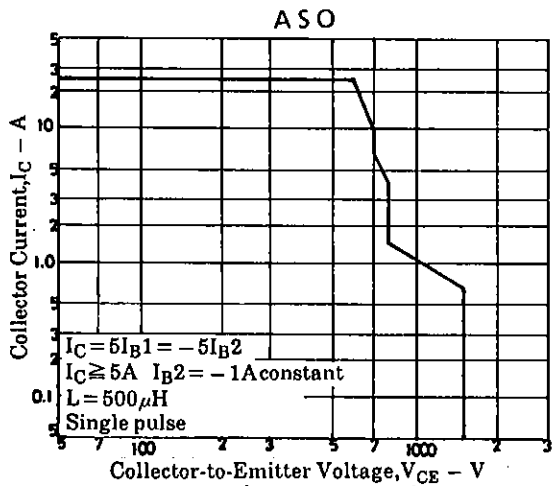
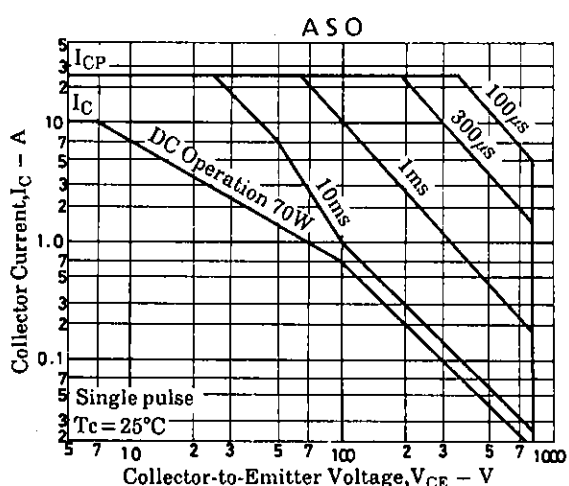
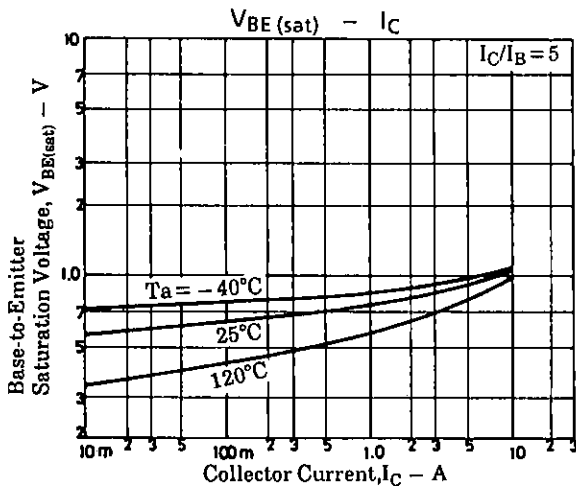
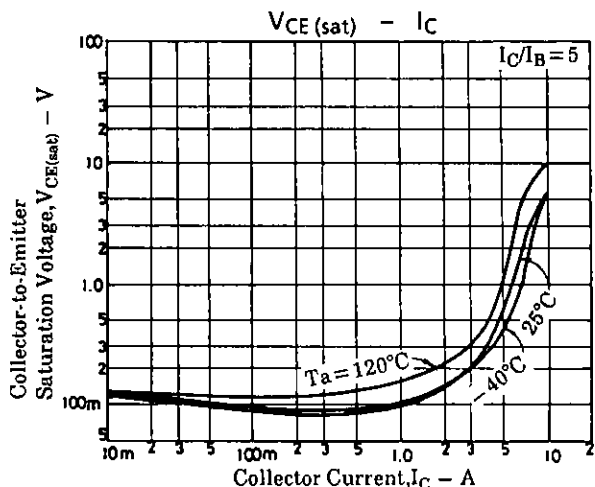
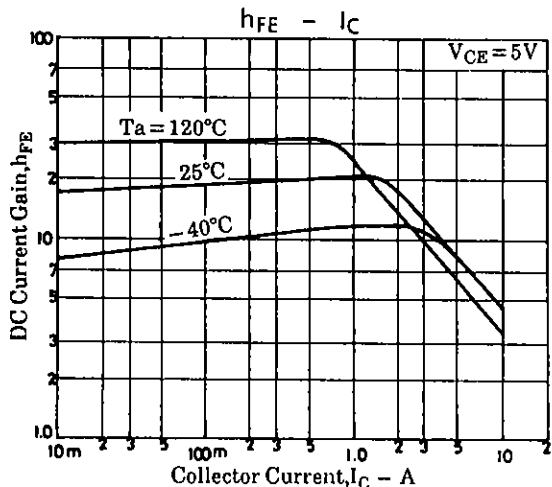
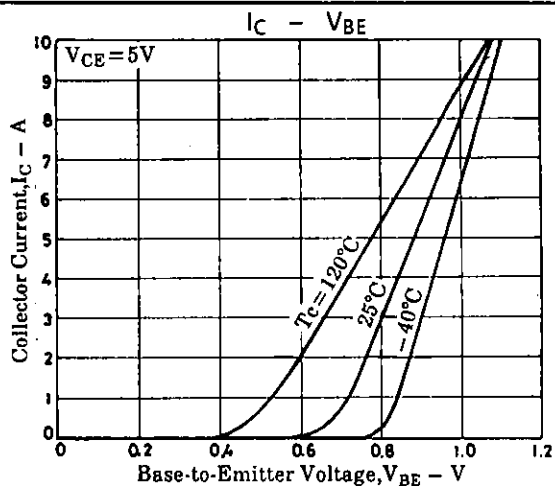
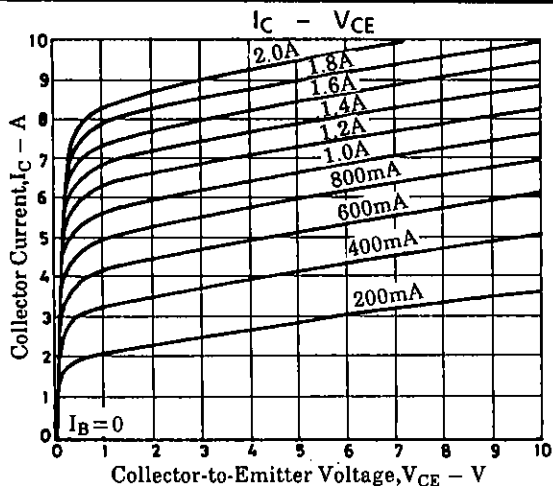

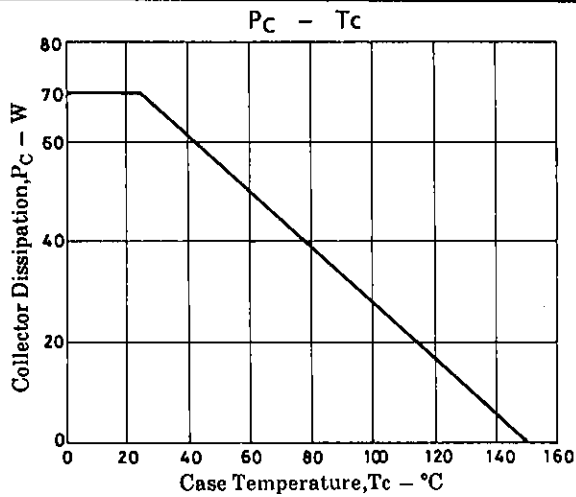

■ No products described or contained herein are intended for use in surgical implants, life-support systems, aerospace equipment, nuclear power control systems, vehicles, disaster/crime-prevention equipment and the like, the failure of which may directly or indirectly cause injury, death or property loss.

■ Anyone purchasing any products described or contained herein for an above-mentioned use shall:

- ① Accept full responsibility and indemnify and defend SANYO ELECTRIC CO., LTD., its affiliates, subsidiaries and distributors and all their officers and employees, jointly and severally, against any and all claims and litigation and all damages, cost and expenses associated with such use:
- ② Not impose any responsibility for any fault or negligence which may be cited in any such claim or litigation on SANYO ELECTRIC CO., LTD., its affiliates, subsidiaries and distributors or any of their officers and employees jointly or severally.

■ Information (including circuit diagrams and circuit parameters) herein is for example only; it is not guaranteed for volume production. SANYO believes information herein is accurate and reliable, but no guarantees are made or implied regarding its use or any infringements of intellectual property rights or other rights of third parties.